

# PAPER FLOWERS

ALICIA HERMAN

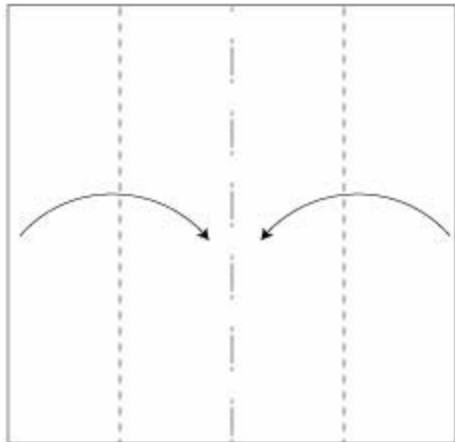

Format digital image to 6" x 6." Print on photo quality matte paper. Cut out and place image side down.

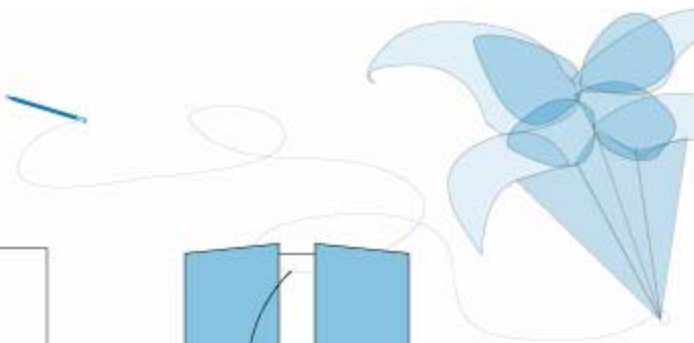
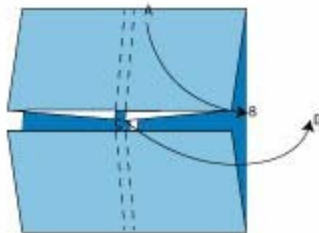
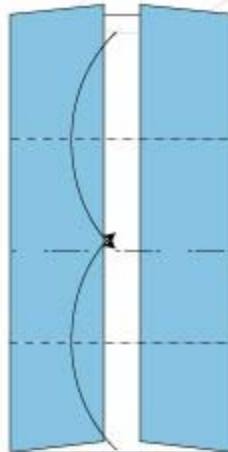

Take inside corner A, fold to B, Fold C to D.

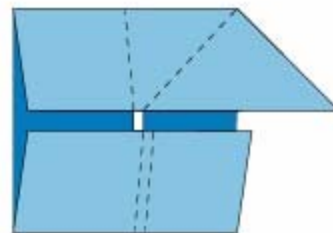

Repeat all sides.

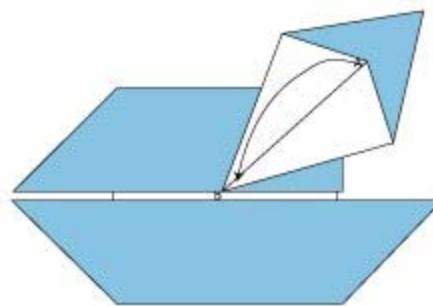
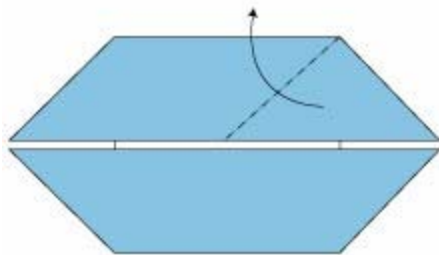

Open and fold A to B.

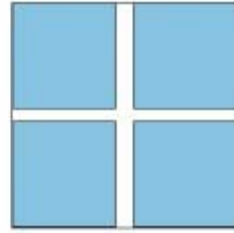
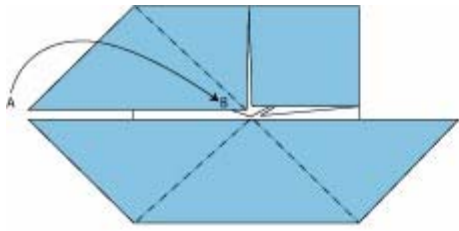

Repeat all sides.

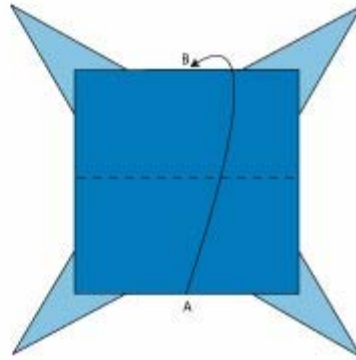
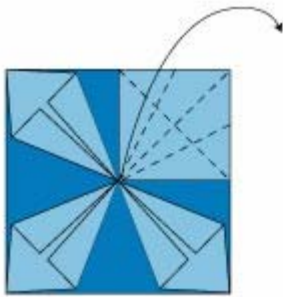
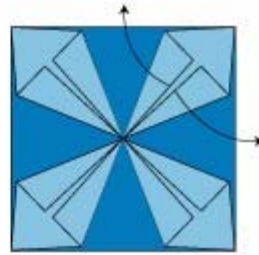
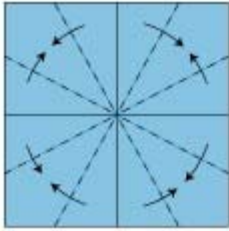

Flip upside down.

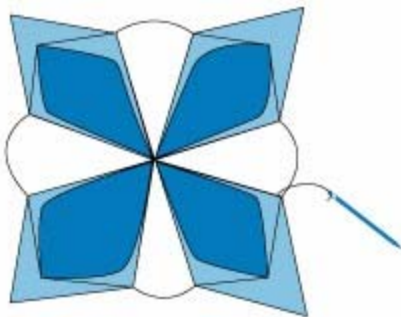
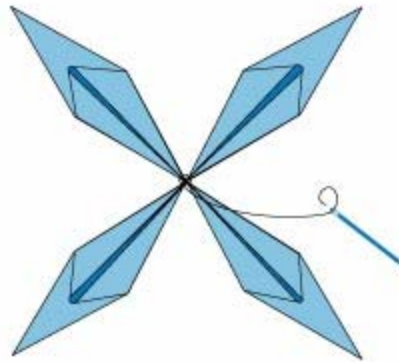
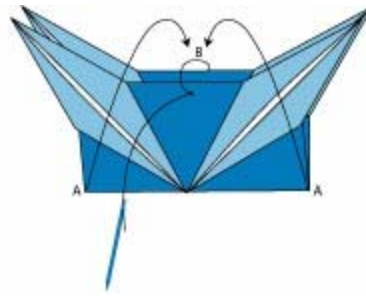

Curl petals with pencil.  
Sew to a stick or flower stem.